

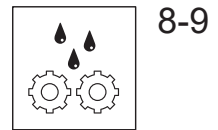

HANSA

Installation and maintenance guide

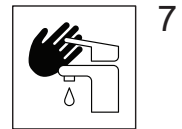



5245 0167

EN 817
50 - 1000 kPa
max. +80°C

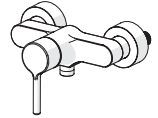
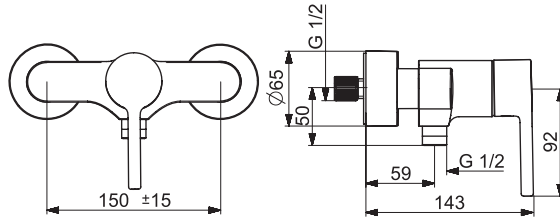

mpi.hansa.com/52450167

5244 2267

EN 817
50 - 1000 kPa
max. +80°C

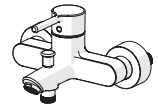
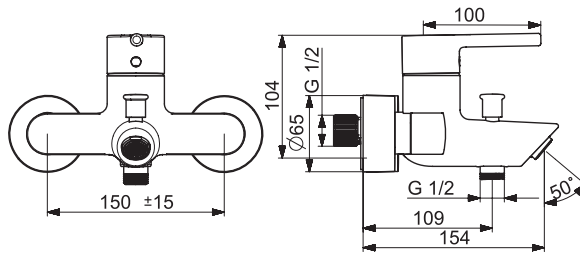

mpi.hansa.com/52442267

5445 0107

I (ISO 3822)
EN 817
50 - 1000 kPa
0.21 l/s (300 kPa)
max. +80°C

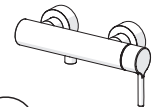
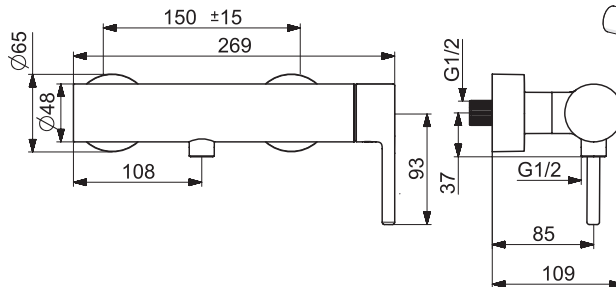

mpi.hansa.com/54450107



5444 2207

EN 817
50 - 1000 kPa
max. +80°C

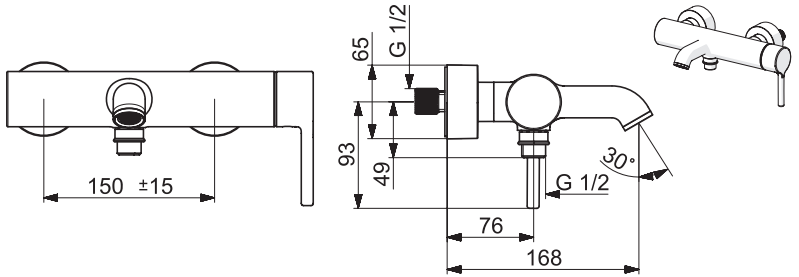

mpi.hansa.com/54442207

5245 0163

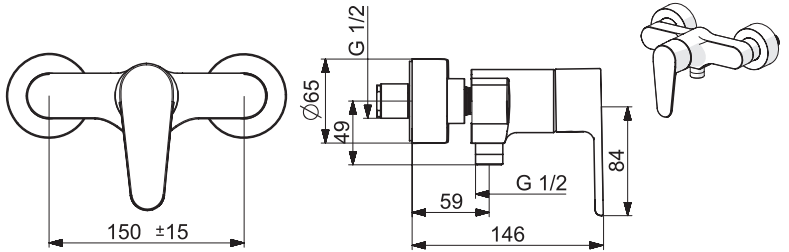

mpi.hansa.com/52450163

5244 2263

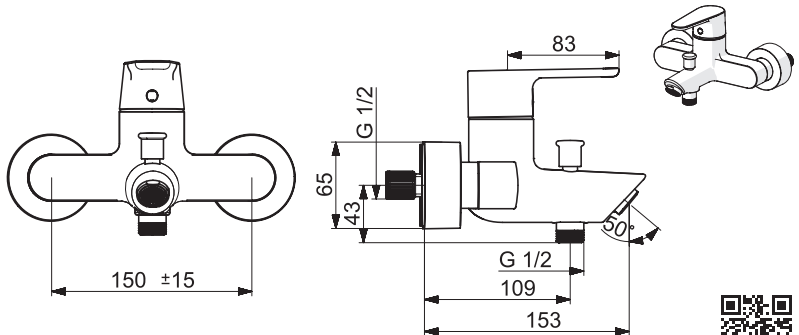

mpi.hansa.com/52442263

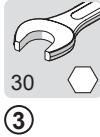
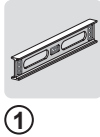
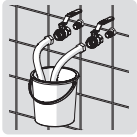
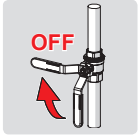

max.
1600 kPa

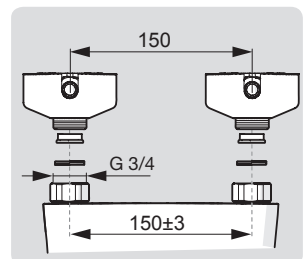
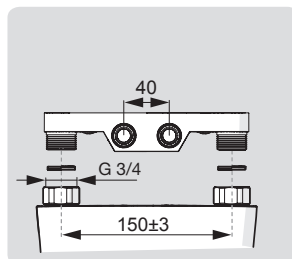
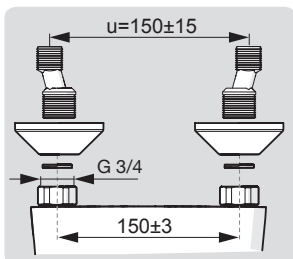
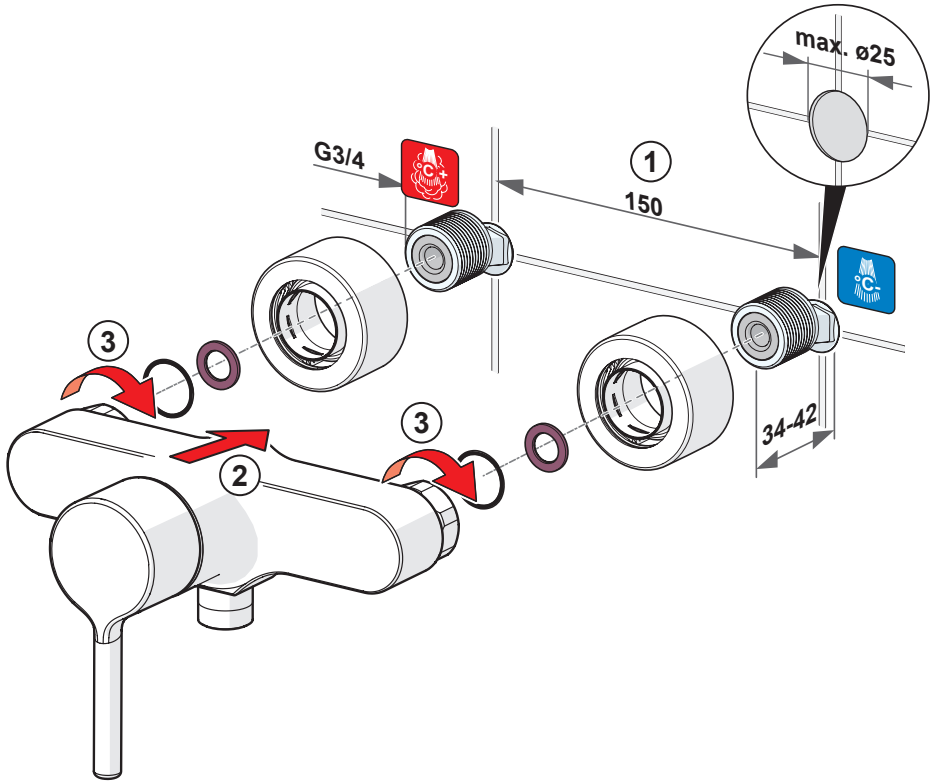

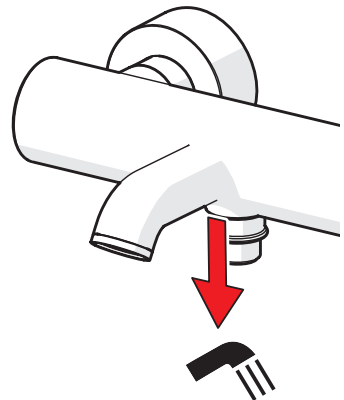
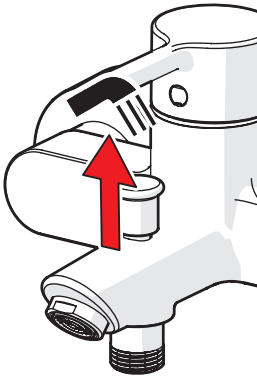

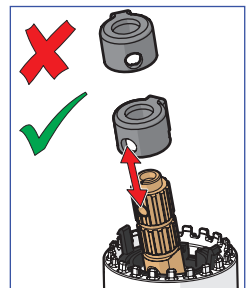
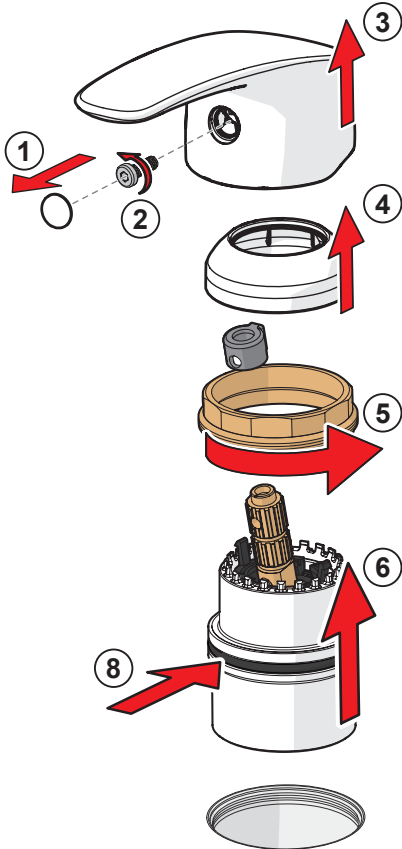
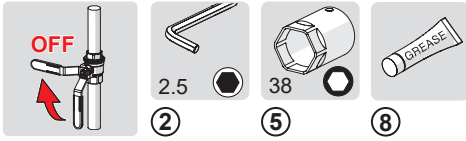



①

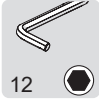

③

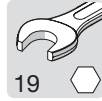

②

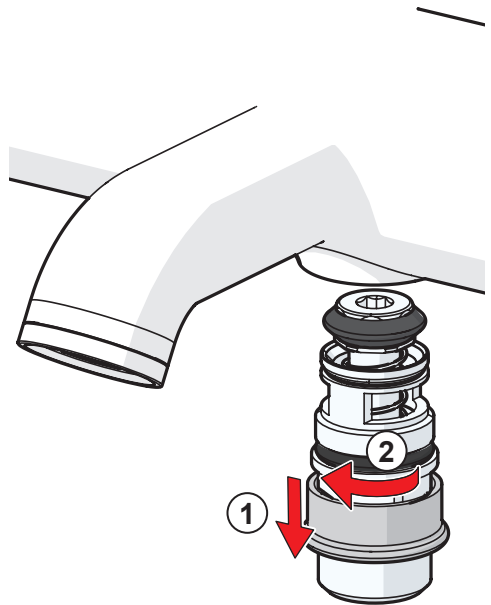
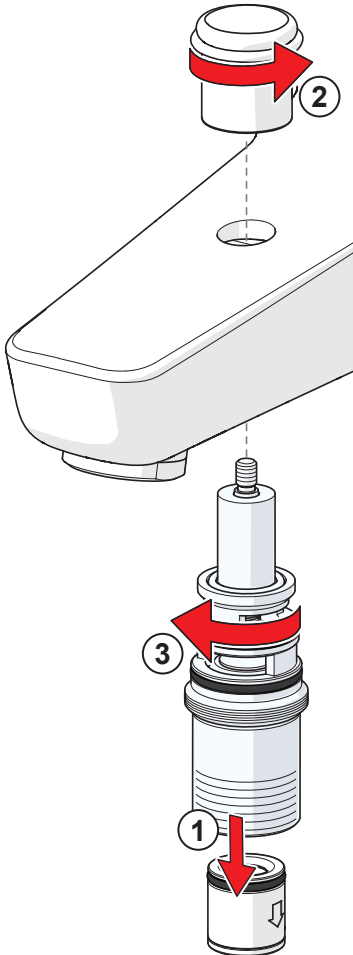



A1



B1



2

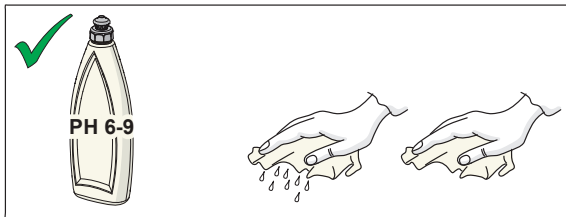
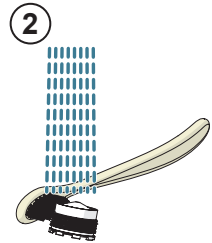
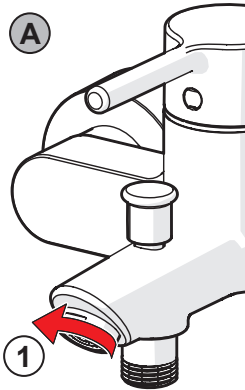

cleaning.hansa.com

About Oras Group

Oras Group is a significant European provider of sanitary fittings: the market leader in the Nordics and a leading company in Continental Europe.

The company's mission is to create the smartest water experiences for everyone and its vision is to become the Perfect Flow Company.

The Group has two strong brands, Oras and Hansa. Oras Group is owned by Oras Invest, a family company, and an industrial owner.

The domicile of Oras Ltd, the parent company of the Group, is located in Rauma, Finland, and the Group has three manufacturing sites: Kralovice (Czech Republic), Olesno (Poland) and Rauma (Finland).

The Group operates with its own staff in 17 markets. Oras Group's net sales were 233.5 million euros in 2021 and at the end of the period the company employed 1255 people.

HANSA Armaturen GmbH
P. O. BOX 81 02 40
D-70519 Stuttgart
Sigmaringer Strasse 107
D-70567 Stuttgart
Tel.: +49 711 16 14 0
Fax: +49 711 16 14 368
info@hansa.de
www.hansa.com

